

Folds---compression

Still more modifiers	Modifiers	Root word
Symmetrical	Non-plunging (RR tracks)	Anticline
Asymmetrical		Syncline
Overturned	direction-plunging (U-shaped)	
Recumbant		Monocline
	(Bull's eye)	Dome Structural basin

At home exercises following the instructions of the teacher.

You will need some blank pieces of paper, pencils, eraser, and at least four hot dog buns (yes, I said hot dog buns).

**Geologic
column**

**(we will use this when
necessary)**

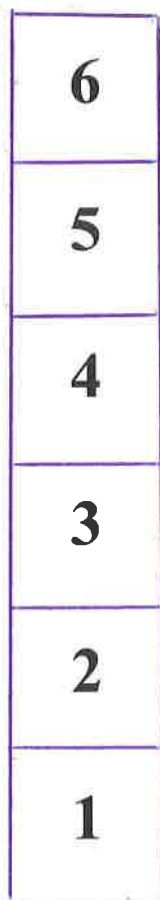

youngest



oldest

Label the parts of the horizontal folds shown in the block diagram below, using the following terms: anticline, syncline, fold limb, common limb, fold hinge, hinge plane

- a. _____
- b. _____
- c. _____
- d. _____
- e. _____
- f. _____

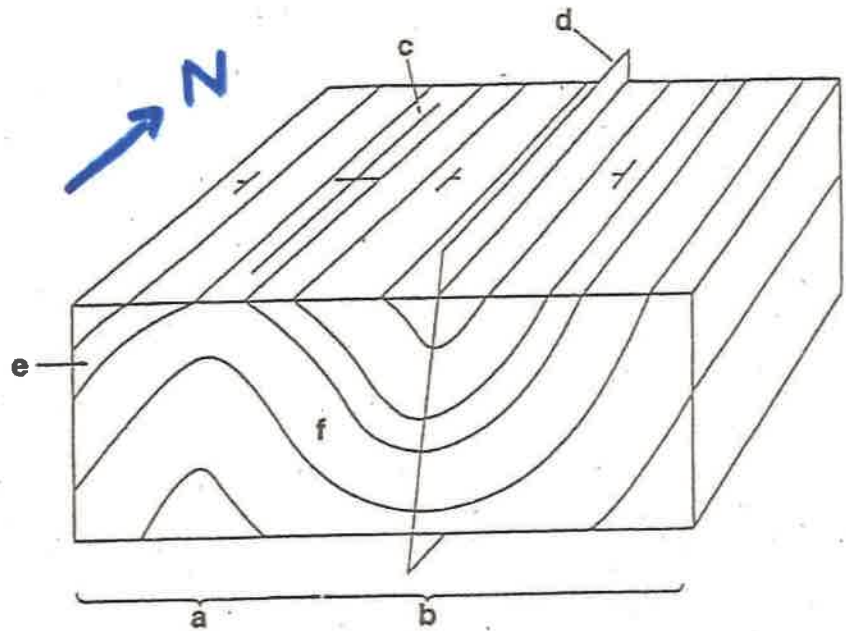

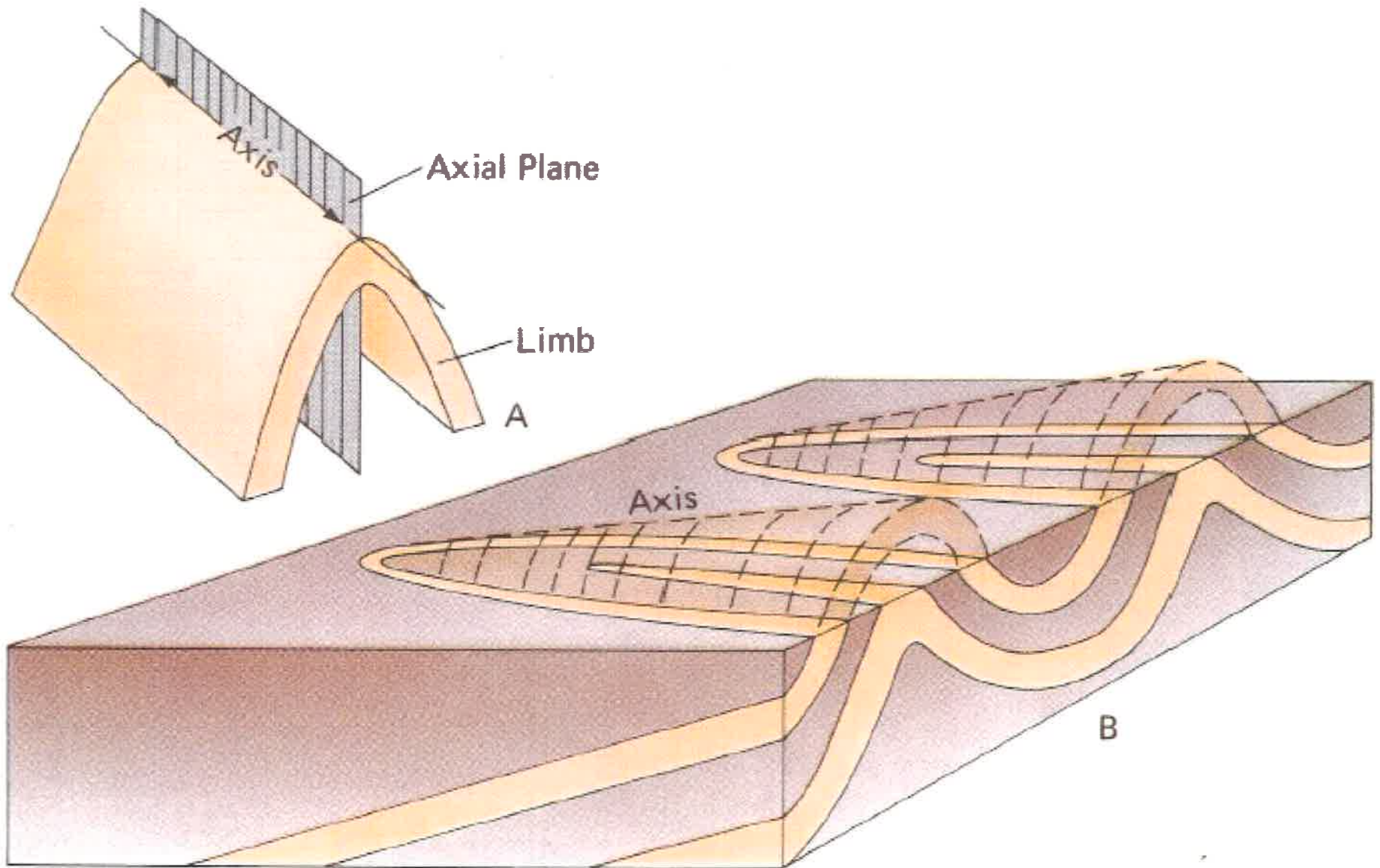

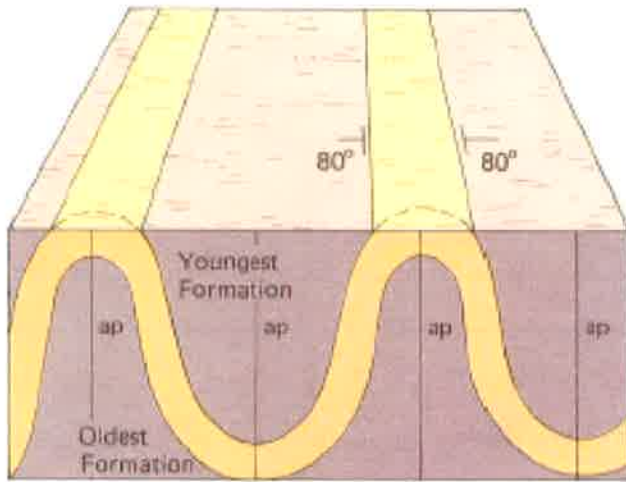

A

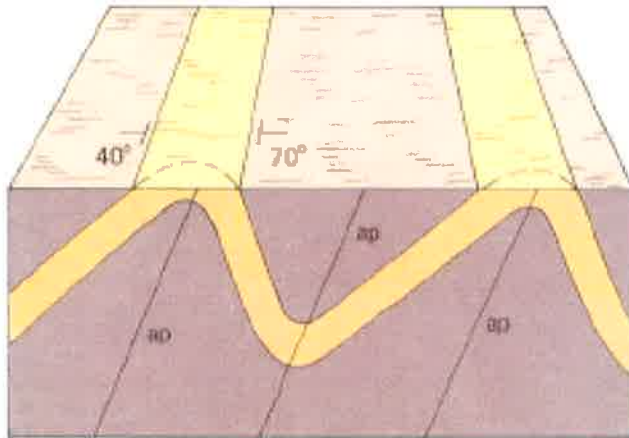

B

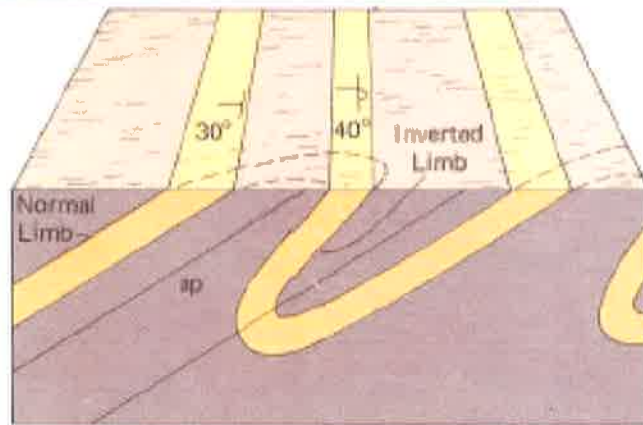

C

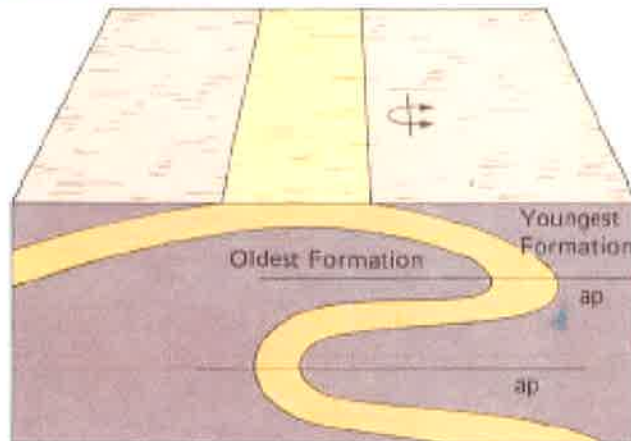

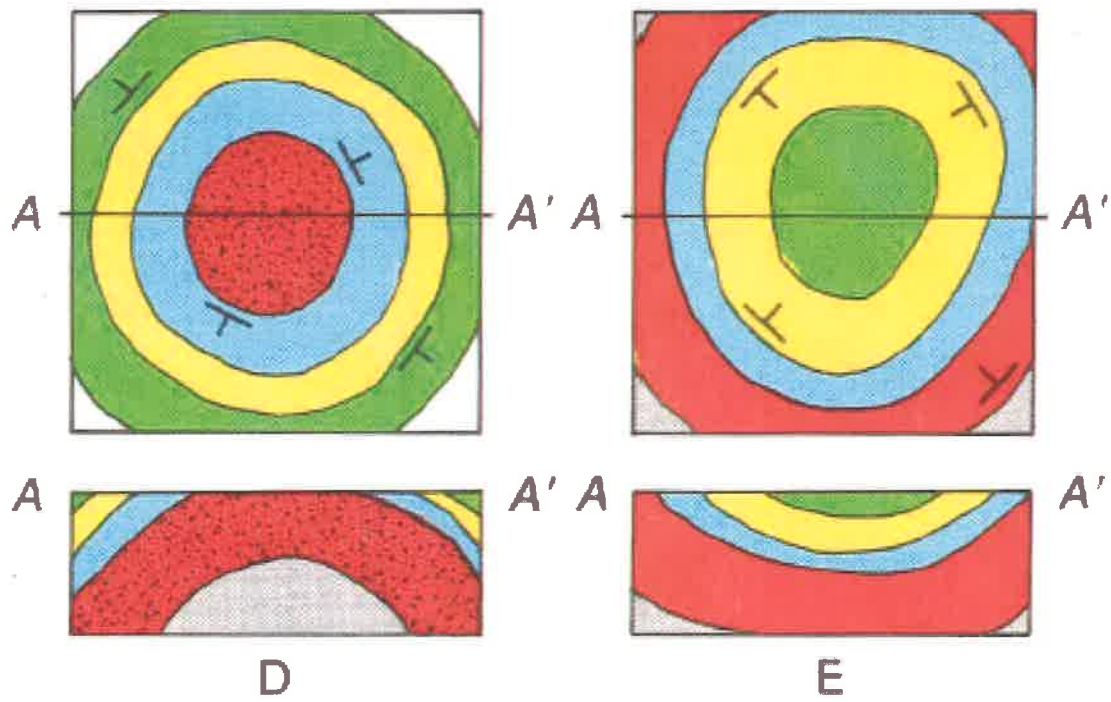
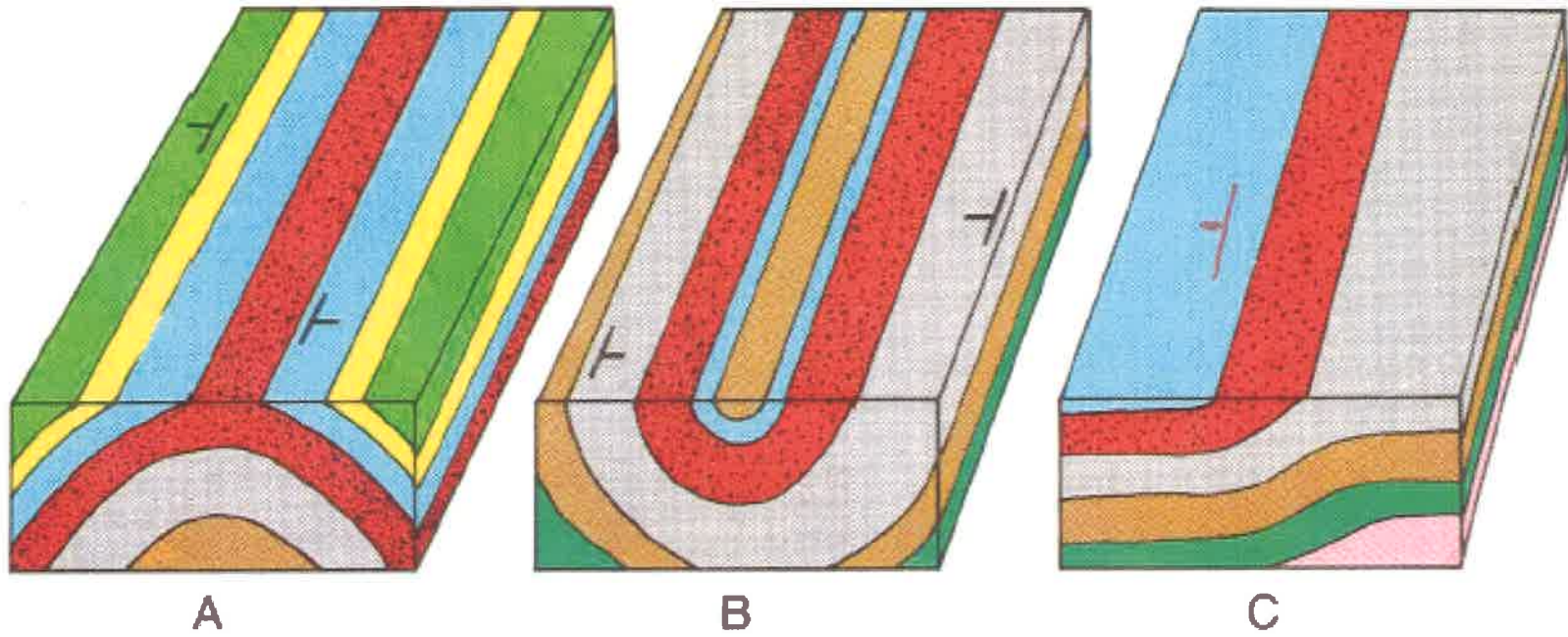

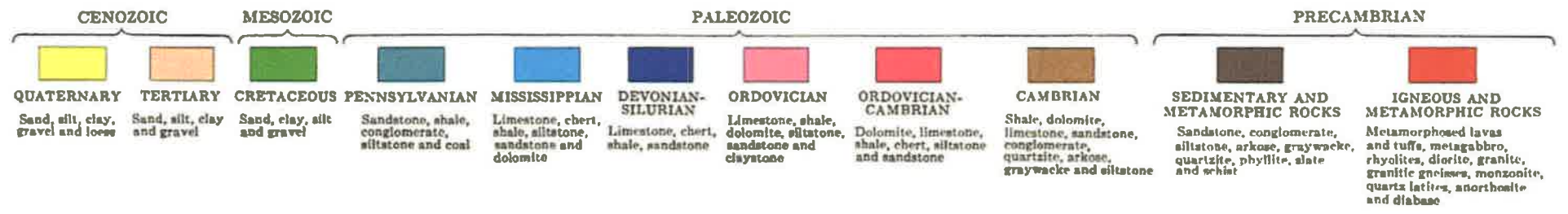
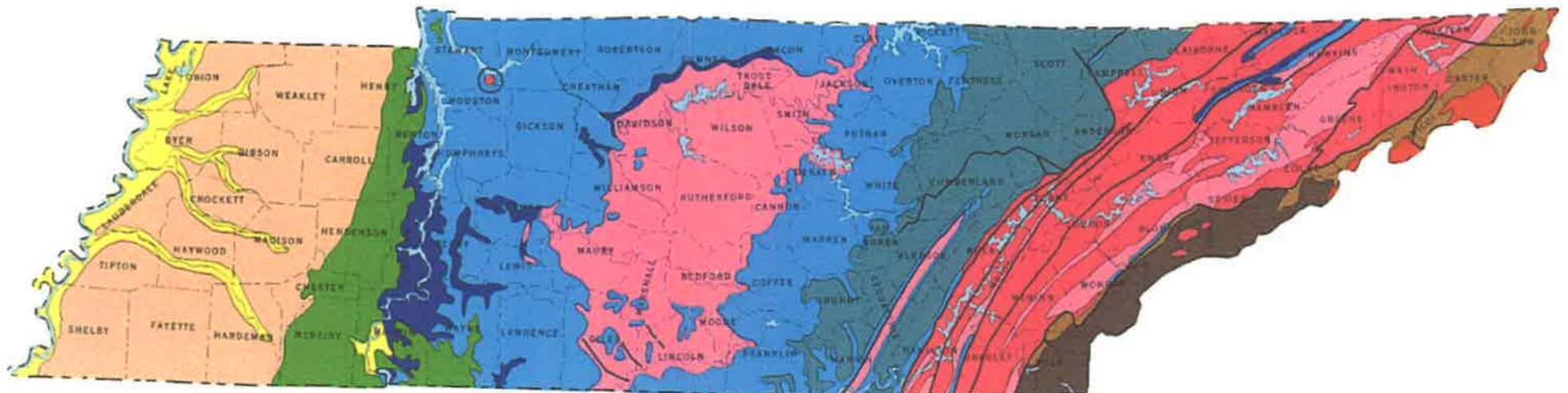

GENERALIZED GEOLOGIC MAP OF TENNESSEE